

E. MAYNARD.
 Double Barrelled Fire Arm.

No. 83,194.

Patented Oct. 20, 1868.

FIG. 1.

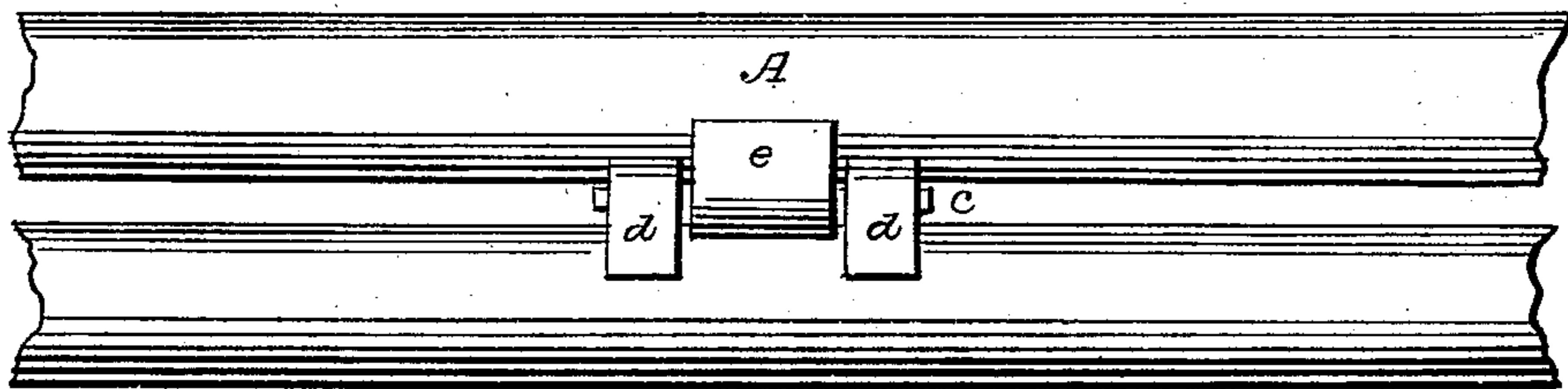

FIG. 2.

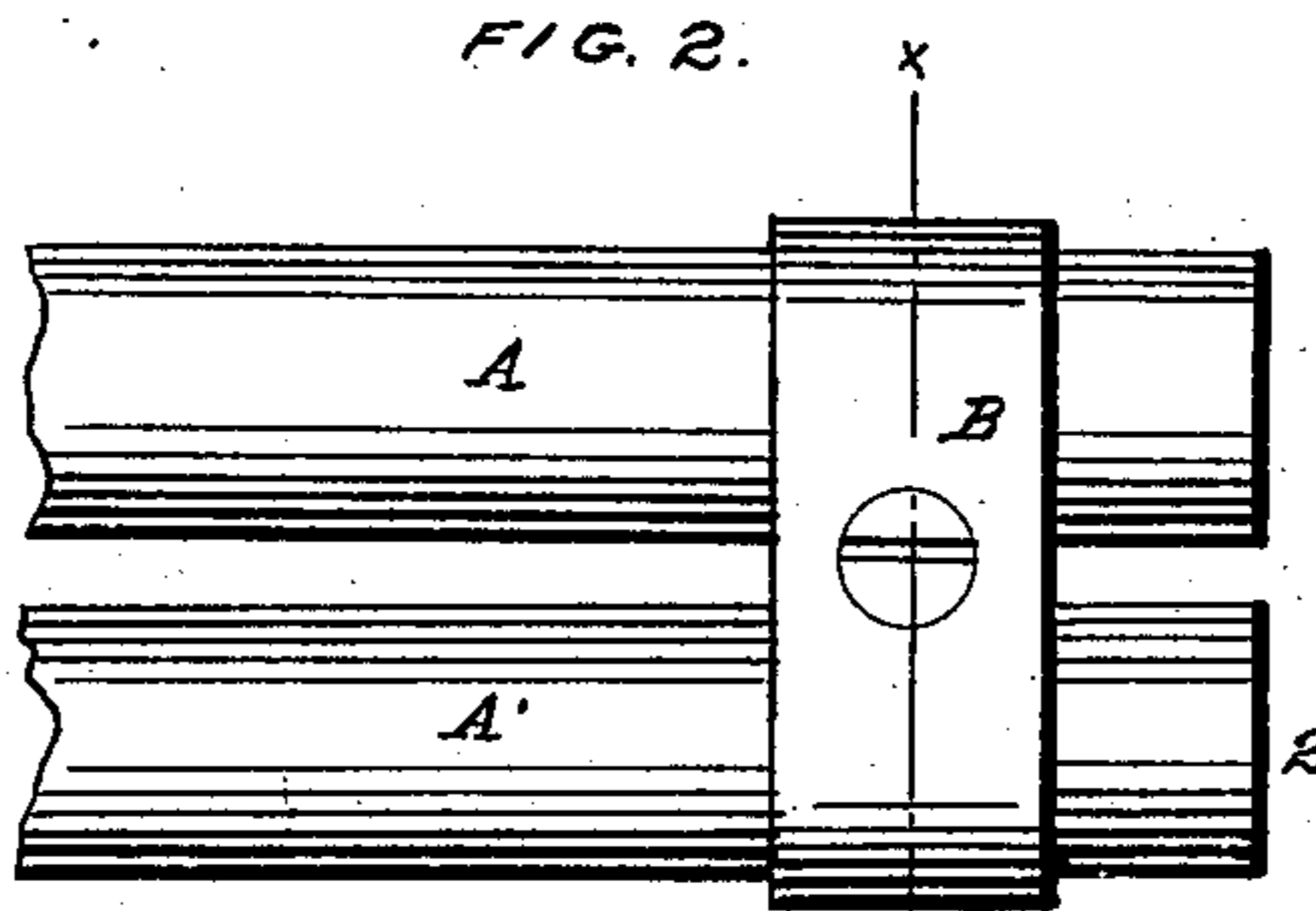

FIG. 9.

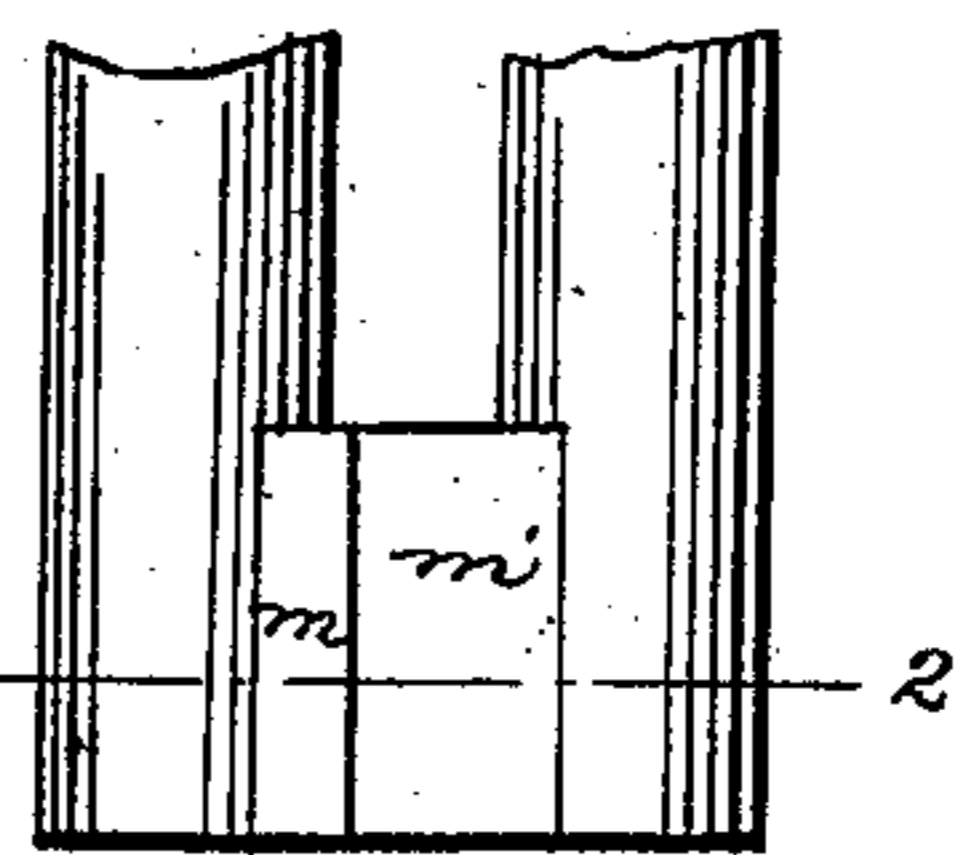

FIG. 10.



FIG. 3.

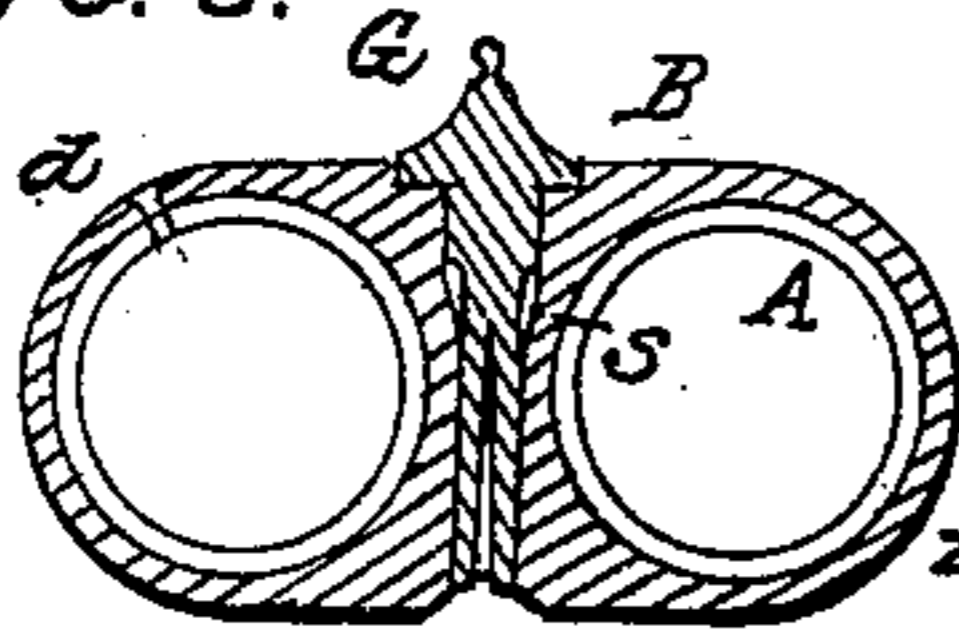

FIG. 5.

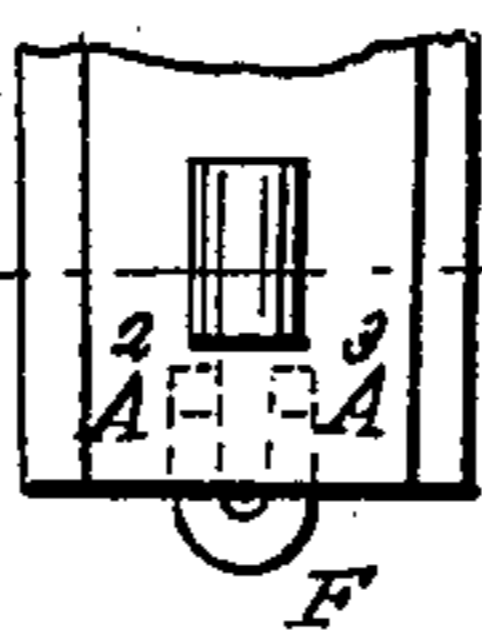

FIG. 7.

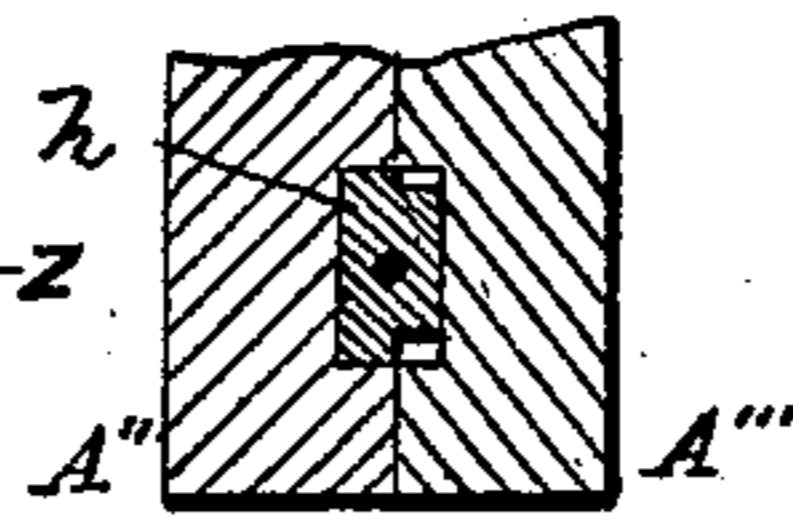

FIG. 6.

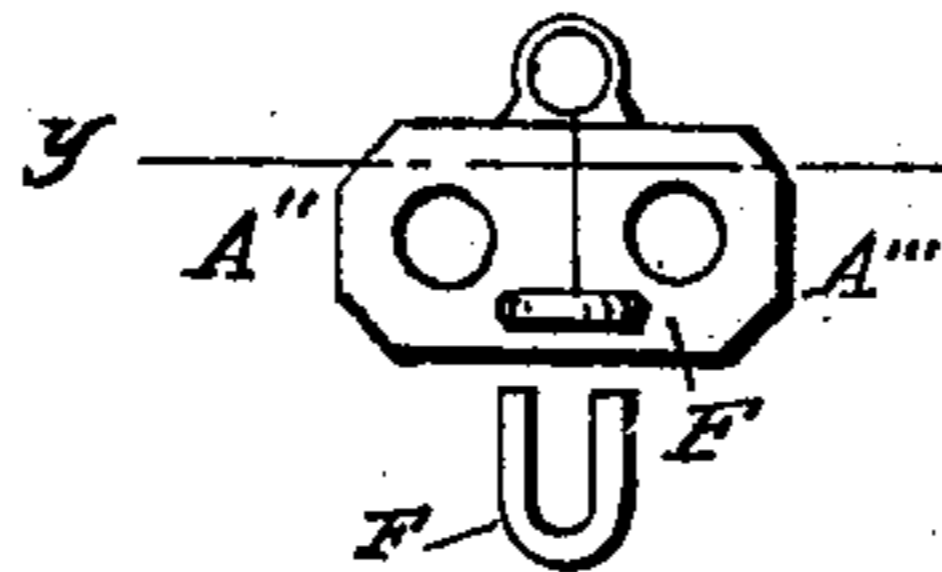
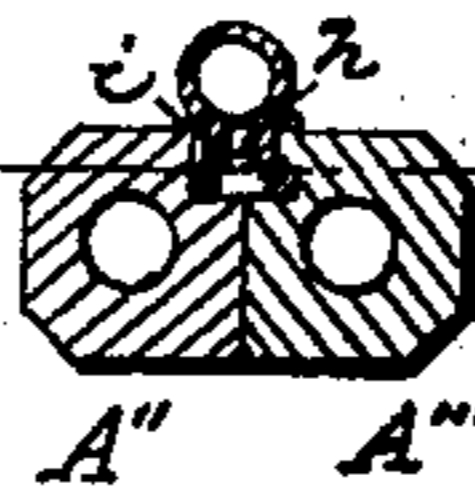

FIG. 8.



WITNESSES:

H. H. Young
Wm. J. Collins

INVENTOR.
 Edward Maynard
 By *J. A. Burr*
 Atty.

United States Patent Office.

EDWARD MAYNARD, OF TARRYTOWN, NEW YORK.

Letters Patent No. 83,194, dated October 20, 1868.

IMPROVEMENT IN DOUBLE-BARRELLED FIRE-ARMS.

The Schedule referred to in these Letters Patent and making part of the same.

To all whom it may concern:

Be it known that I, EDWARD MAYNARD, of Tarrytown, in the county of Westchester, and State of New York, have invented new and useful Improvements in Double-Barrelled Guns; and I do hereby declare the following to be a full, clear, and exact description thereof, reference being had to the accompanying drawings, forming a part of this specification, in which—

Figures 1 and 2, 5 and 9, are plan views of my improved devices for uniting the barrels of double-barrelled guns.

Figure 3, a transverse section in line *x x*, fig. 2.

Figure 6, an end view, on a reduced scale, of the end of the barrels of a double-barrelled gun, united by means of a staple, as shown in plan in fig. 5, and a view, also, of staple detached.

Figure 7, a horizontal section in line *y y* of figs. 6 and 8, showing arrangement and combination of retaining-plate with the barrels.

Figure 8, a transverse section in line *z z* of fig. 5.

Figure 9, a plan, and

Figure 10, a section, in line 2 2 of fig. 9, illustrating another modification of my invention.

Similar letters indicate like parts in all of the figures.

The nature of my invention consists in so uniting the forward ends of the barrels of a double-barrelled gun, firmly united at the breech, as that either barrel may expand or contract independently of the other, yet without disturbing their relative position and lateral adjustment.

In double-barrelled guns, especially in guns having both rifled and shot-barrels combined, it often happens that one of the barrels, being used more than the other, becomes so much the more heated as to cause, by its expansion, a deviation in the axis of the gun, along its length, from a right line, producing a deflection in the line of sight prejudicial to perfect accuracy in aim.

To overcome this difficulty, I form the two barrels *A A'* independently of each other, either of a cylindrical form, (figs. 1, 2, 3, 9 and 10,) or with plane sides to fit closely together, as shown in figs. 5 to 8, and then securing them firmly together at the butt by screws or other fastenings, fixed or detachable, pass their outer ends through a double ferrule, *B*, (see figs. 2 and 3,) in the which one of them, *A*, fitting closely, is left free to play or move longitudinally, whilst the other, *A'* is rigidly secured thereto by a screw, *a*, or other fastening.

As an equivalent for the double ferrule *B*, (fig. 3,) and to accomplish the end of my invention, I contemplate uniting the barrels by a hinge-joint and pin, *c*, as illustrated in fig. 1. In this device, the pin *c* is firmly secured to one of the barrels *A*, but plays freely in the ears *d d* projecting from the other, whilst the central projection *e* of the joint is so proportioned as to allow it a free longitudinal play between the other two, *d d*, as illustrated in fig. 1.

Figs. 5 and 6 illustrate another equivalent device, applicable more especially to heavy, solid barrels, which

are united closely, so as to present a homogeneous aspect. In this case, the ends of the barrels are each drilled to receive a staple, *F*, one arm of which is firmly secured in the recess formed in one barrel, whilst the other arm, fitting closely into the recess in the adjoining barrel, is left free therein.

This staple *F* will prevent the lateral divergence of the barrels. In connection therewith, I insert a plate, *h*, (fig. 7,) by preference, rectangular in form, having grooves, *i i*, cut longitudinally therein, on either side thereof, into and between recesses cut to embrace it in the adjacent faces of the two barrels *A A'*, fig. 7. Projections, fitting into and which may slide in the grooves *i i* of the plate, secure and prevent a vertical movement of either barrel; and, whilst the plate *h* fits so closely into the recess in one barrel, *A*, as to become fixed thereto, the recess in the other barrel, *A'*, is so extended, longitudinally, or the portion of the base, *h*, fitting therein, is so cut away or shortened in length (see fig. 7) as to allow a limited longitudinal movement of the end of either barrel, without disturbing the proper relative position of their axes, or the true central position of a front sight, *G*, placed upon the plate *h*.

Where a ferrule, *B*, is used, I insert the front sight in said ferrule.

Figs. 9 and 10 illustrate yet another device for carrying out my invention. It consists of two plates, *m m'*, brazed or otherwise secured to the inner adjacent sides of the barrels, near the ends thereof, which plates are united by a dovetailed projection, formed longitudinally on one plate, *m*, sliding and fitting closely into a counterpart recess in the other plate, *m'*, forming a joint, which, although allowing a free, independent longitudinal movement of the two barrels at this point, yet prevent their lateral or vertical divergence.

Other equivalent mechanical devices, to be securely attached to one of two barrels, and so unite them as to secure their relative adjustment laterally, and yet permit a longitudinal expansion and contraction of the end of either, independently of the other, will suggest themselves, and I contemplate their adoption; and, having thus fully described my invention,

I claim therein as new, and desire to secure by Letters Patent—

Two or more separate gun-barrels, so united and attached together, by means of a projecting ring, plate, staple, or other equivalent device, firmly secured to one barrel, and embracing or entering the adjacent barrel, or a lug or plate projecting therefrom, as to allow any one of them to expand and contract longitudinally, independently of the other, without changing or affecting the relative position of their axes, substantially as herein set forth.

The foregoing specification of my improvements in double-barrelled guns signed by me, this 18th day of January, 1868.

Witnesses:

GEORGE S. TAYLOR,
WM. P. MCFARLAND.

EDWARD MAYNARD.